

RICH AND PEGGY BERTZ  
 1225 INDIANA AVE.  
 NAPOLEON OH 43545

This Blueprint is property to Wayne Homes Bowling Green and under no circumstances to be returned to anyone but Wayne Homes Bowling Green.

2 ST 3 WAYNE HOMES 2 STORY WHISTLER II		
SCALE: 1/4" = 1'	APPROVED BY	DRAWN BY
DATE: 12-10-86	F. E. W.	DS
		DWG NO
		1 of 8

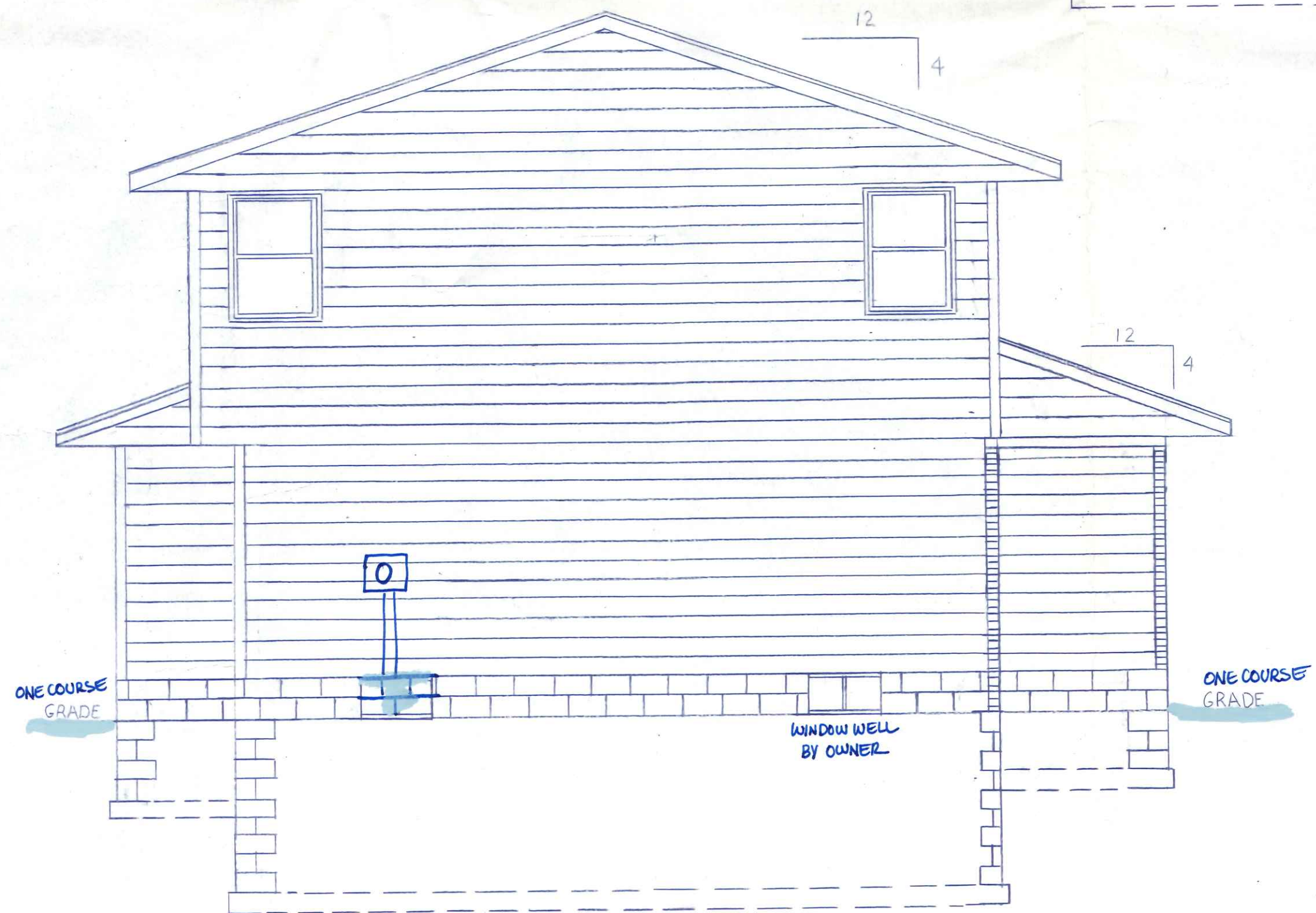
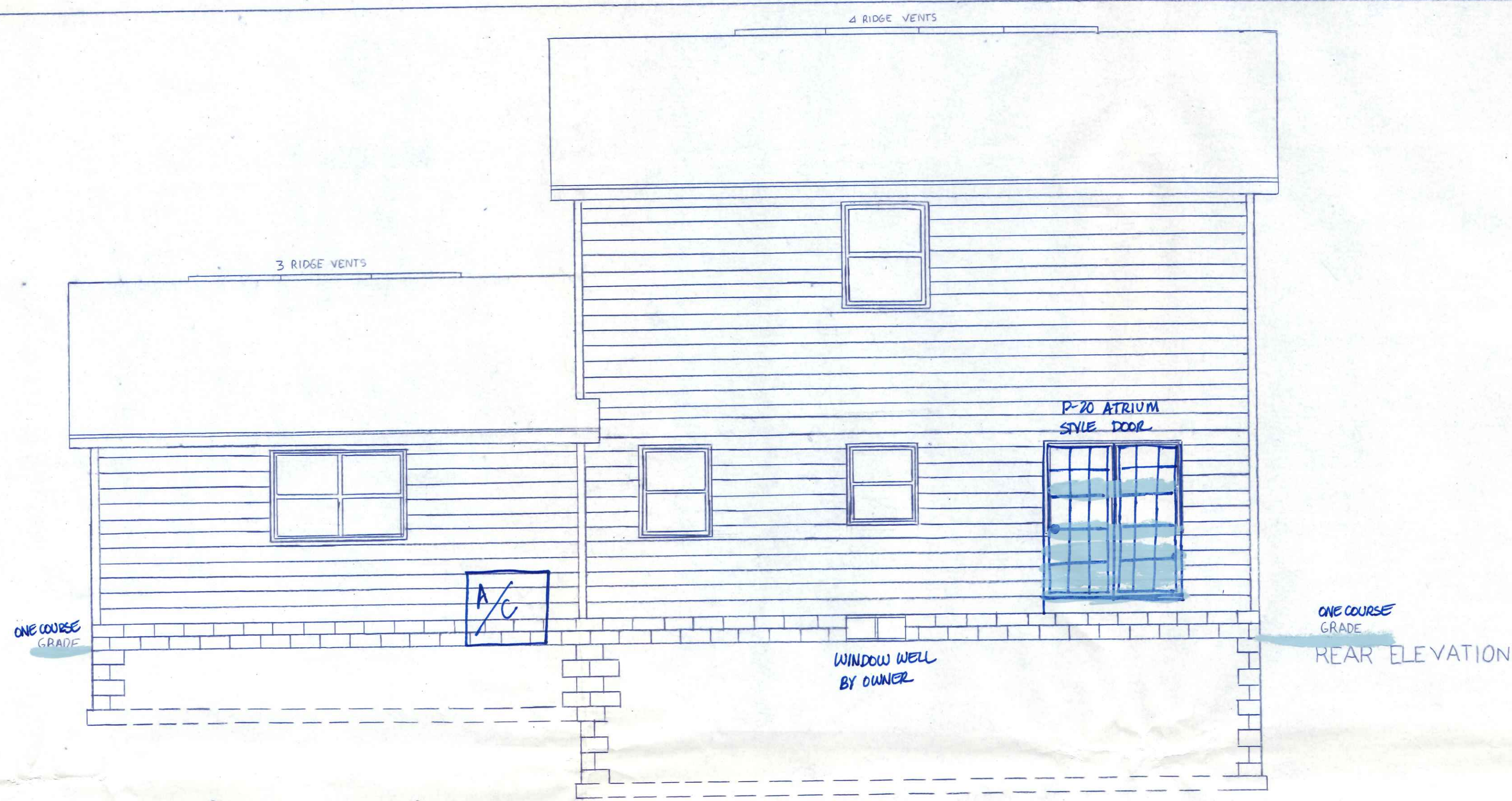

This Blueprint is property to Wayne Homes Bowling Green and under no circumstances to be returned to anyone but Wayne Homes Bowling Green.

2 ST3 WAYNE HOMES 2 STORY WHISTLER II		
SCALE 1/4"=1'	APPROVED BY	DRAWN BY
DATE: 12-10-86	F E W	DS
DWG. NO.		2 OF 8

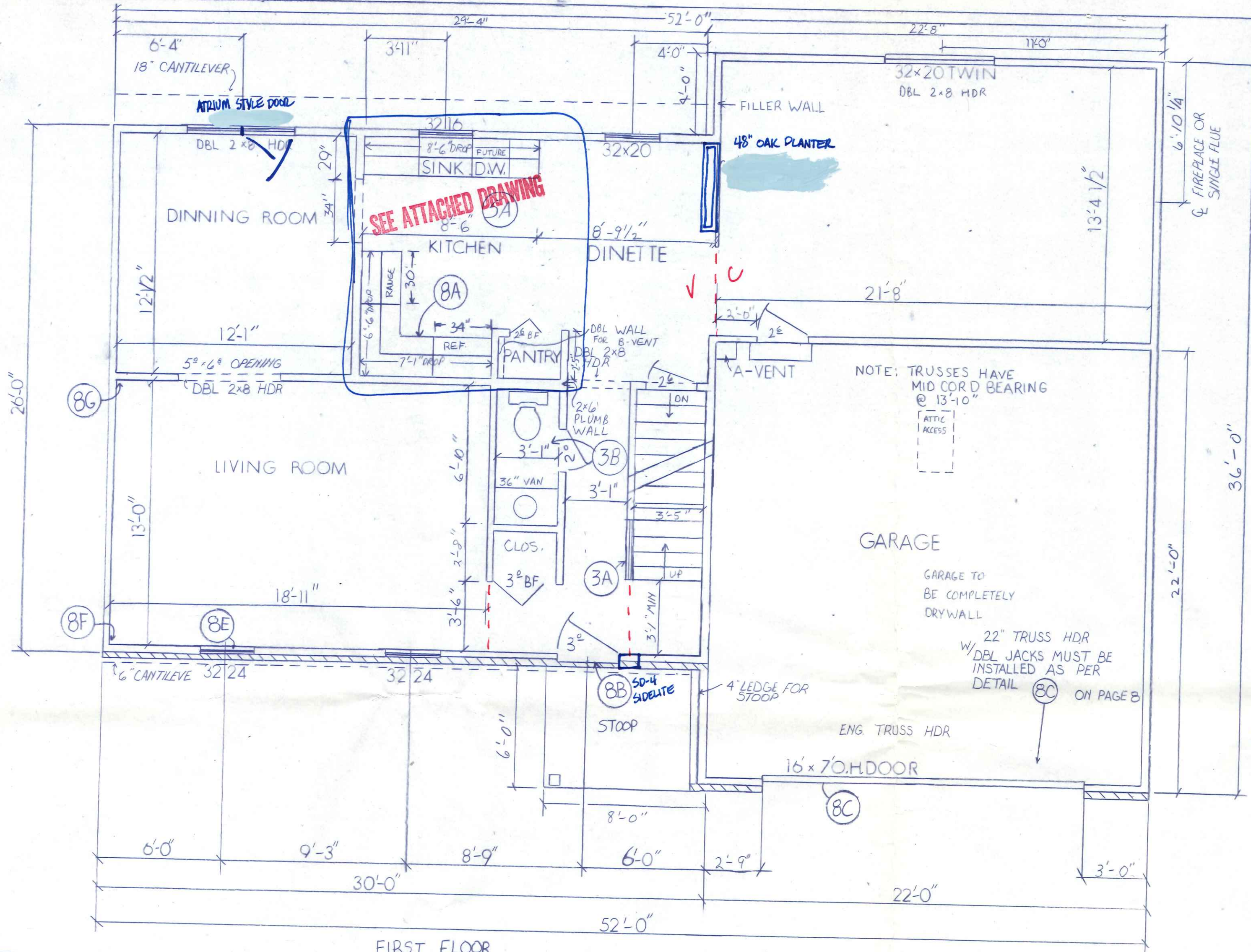

FIRST FLOOR

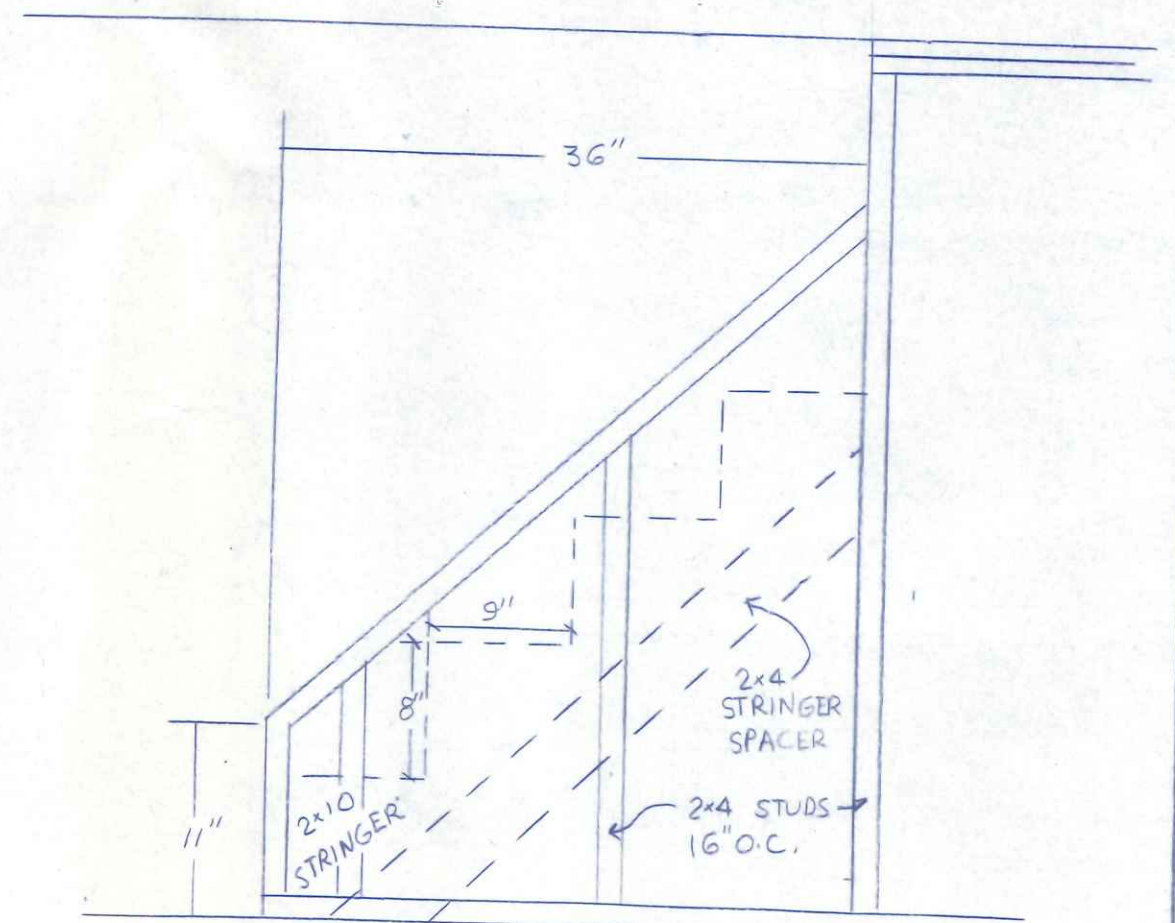

1/2" END OF ROUGH HORSE  
← END OF ROUGH SLOPED WALL  
1/2" PAST END OF ROUGH HORSE

DETAIL OF STAIRWAY FOR ROUGH CRPT.

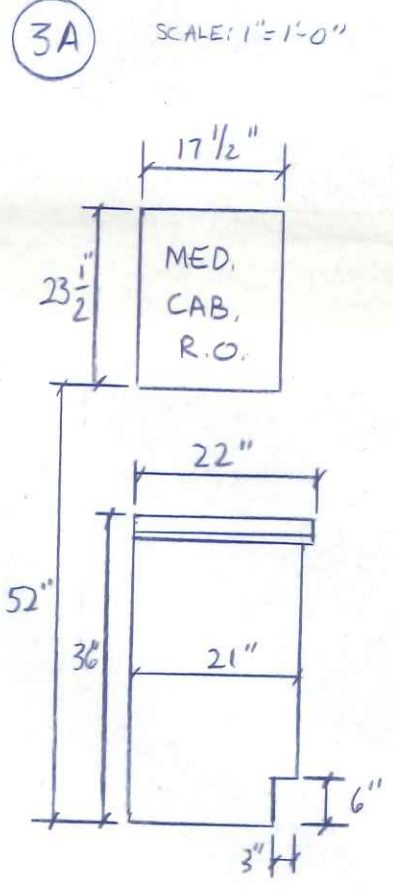
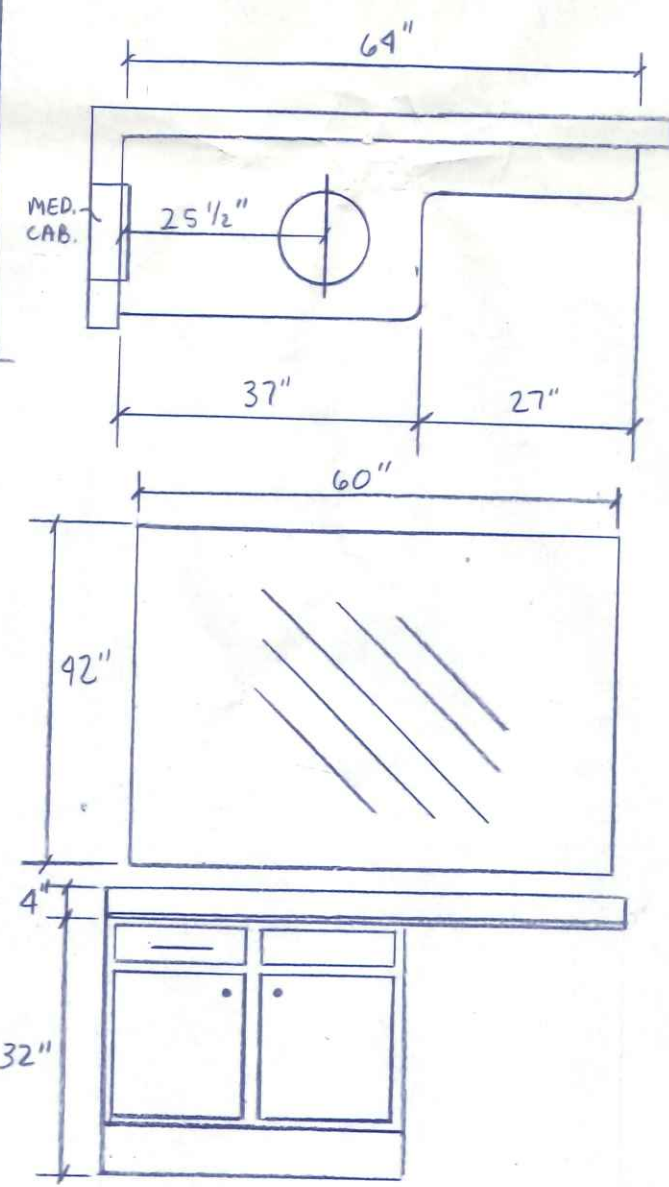

MAIN BATH  
36" VANITY  
SCALE: 1/2" = 1'

3D

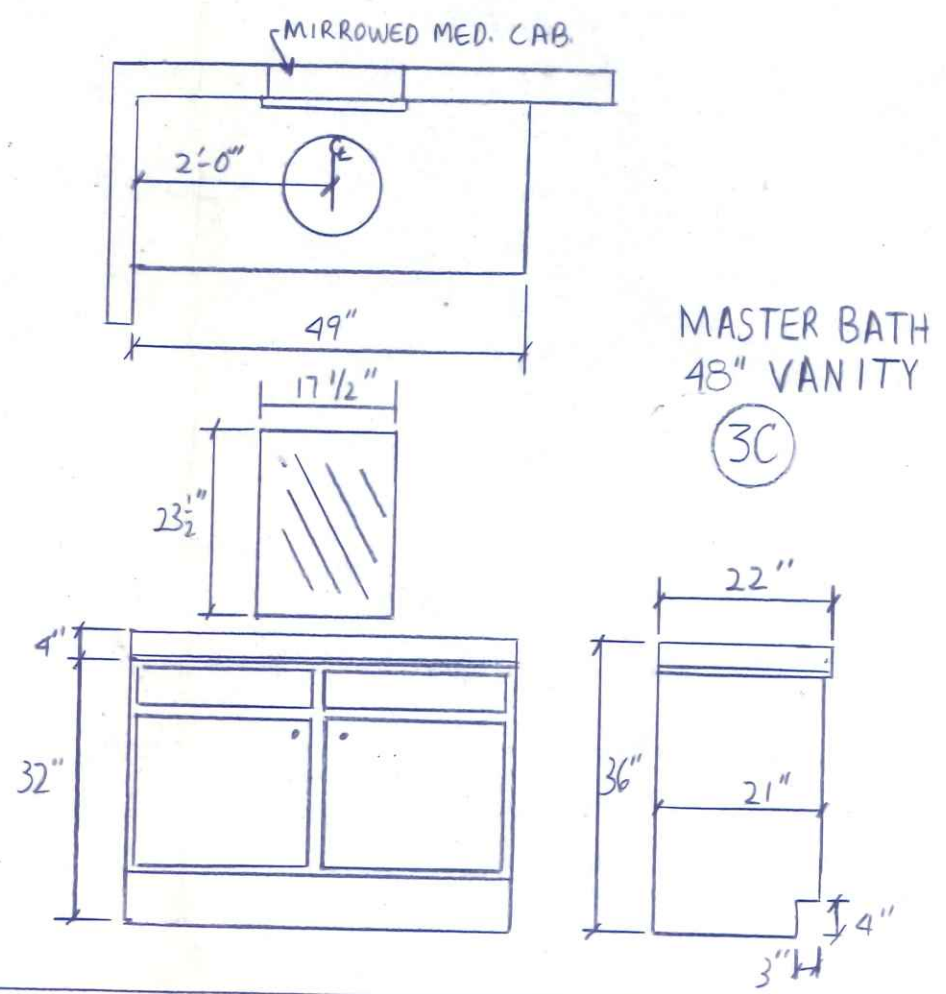

MASTER BATH  
48" VANITY  
3C

1ST FLOOR WINDOW SCHEDULE			
SIZE	WIDTH	HEIGHT	QUANTITY
32x24	3'-2"	4'-9 1/4"	2
32x16	3'-2"	3'-5 1/4"	1
32x20	3'-2"	4'-11 1/4"	1
32x20	6'-3 1/2"	4'-11 1/4"	1
DBL 2x8 HDR	5'-11"	6'-8"	0
DBL 2x8 HDR	6'-1 3/8"	6'-10 1/8"	1

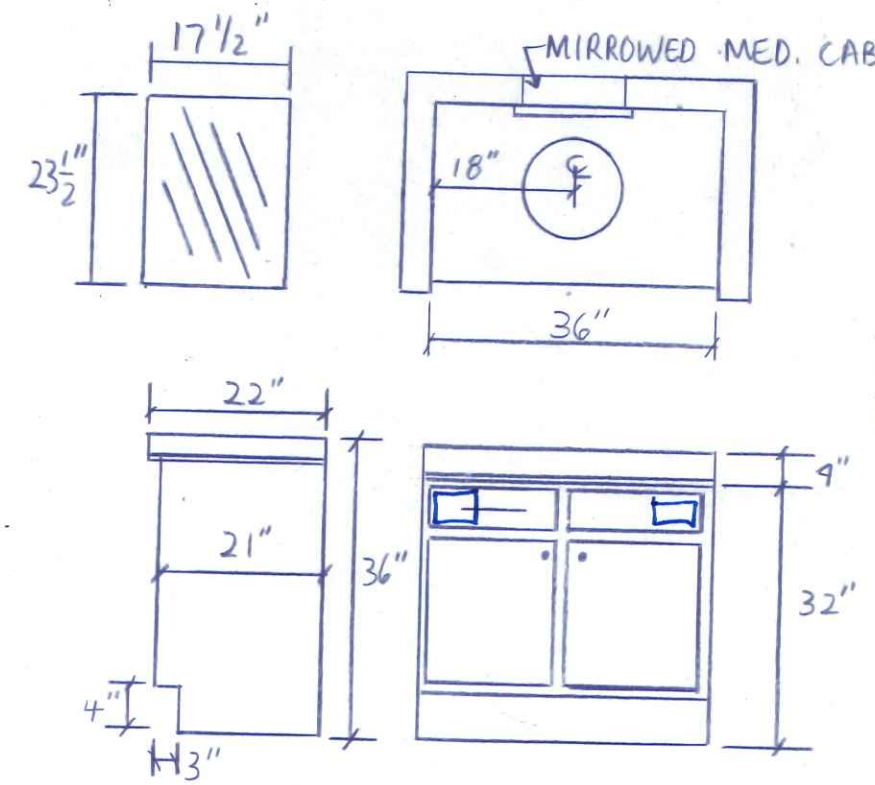

1/2 BATH  
36" VANITY  
3B

This Blueprint is property to Wayne Homes Bowling Green and under no circumstances to be returned to anyone but Wayne Homes Bowling Green.

2 ST 3 WAYNE HOMES  
2 STORY WHISTLER II  
SCALE: 1/4" = 1' APPROVED BY: F.C.W.  
DATE: 12-10-86 DRAWN BY: DS

---

DWG. NO. 3 OF 8

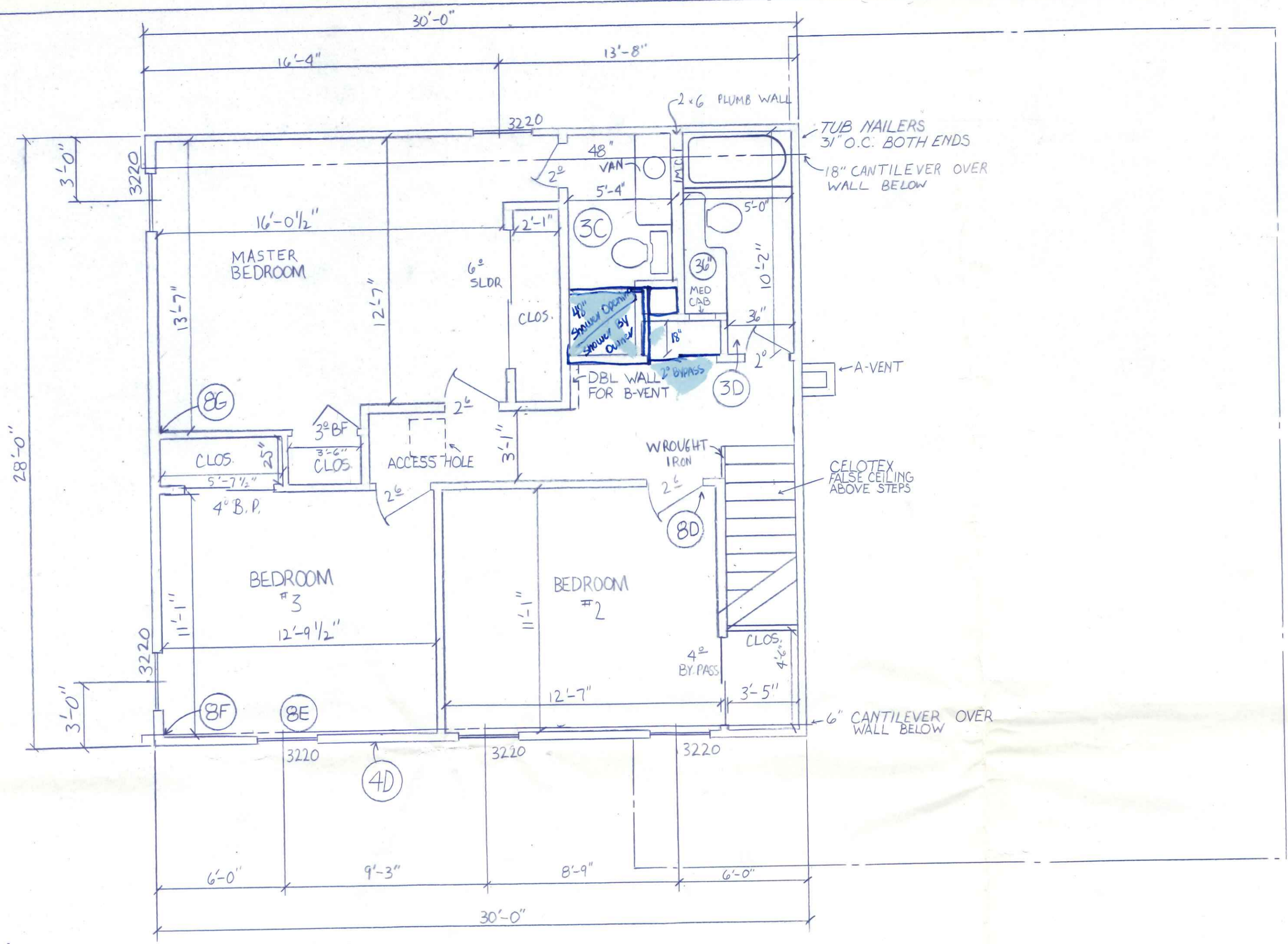

SIZE	WIDTH	HEIGHT	QUANTITY
32x20	3'-2"	4'-1 1/4"	6

SECOND FLOOR

SCALE: 1/2" = 1'-0"

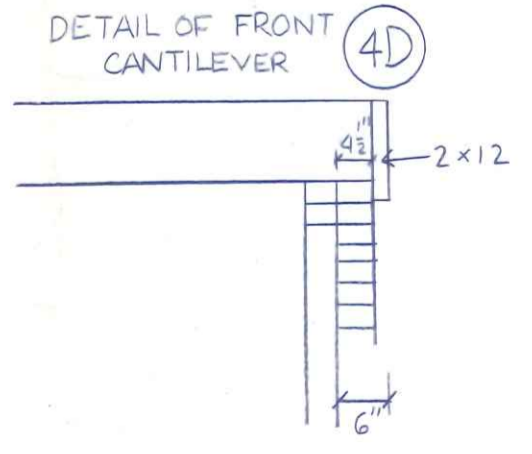

This Blueprint is property to Wayne Homes Bowling Green and under no circumstances to be returned to anyone but Wayne Homes Bowling Green.

2 ST 3 WAYNE HOMES		2 STORY WHISTLER II	
SCALE: 1/4" = 1'	APPROVED BY:	DRAWN BY:	
DATE: 12-10-80	F.E.W.	DS	
DWG. NO.			4#8

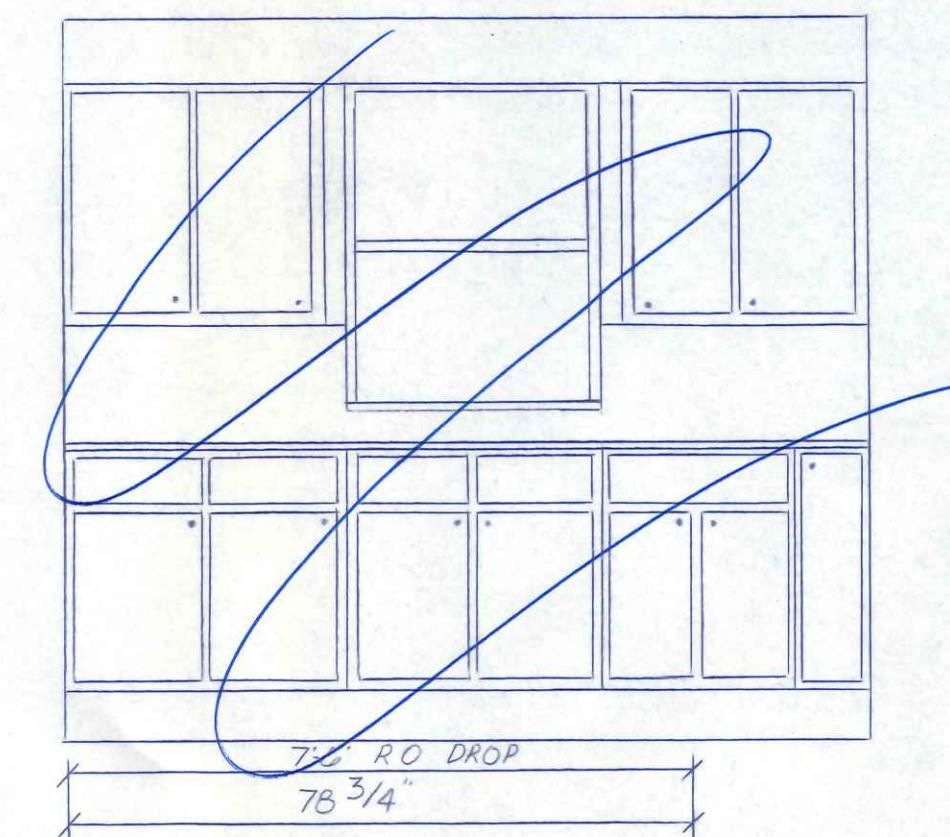
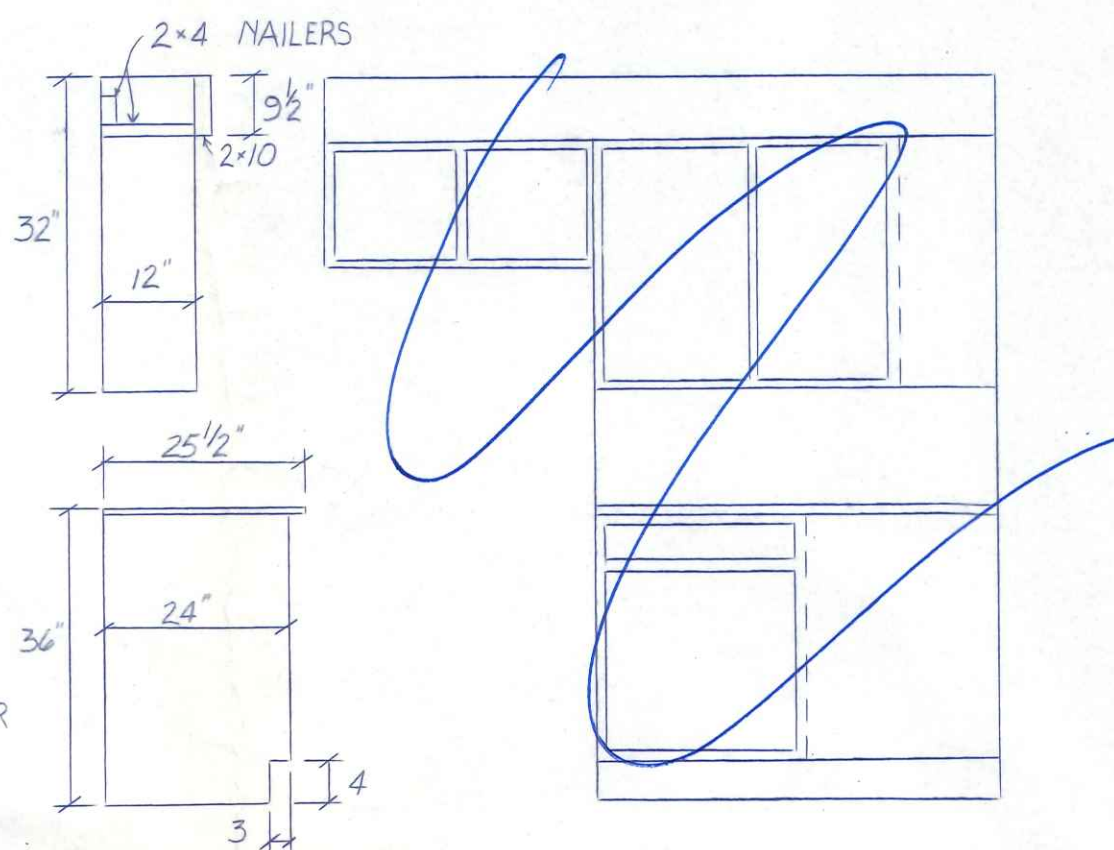
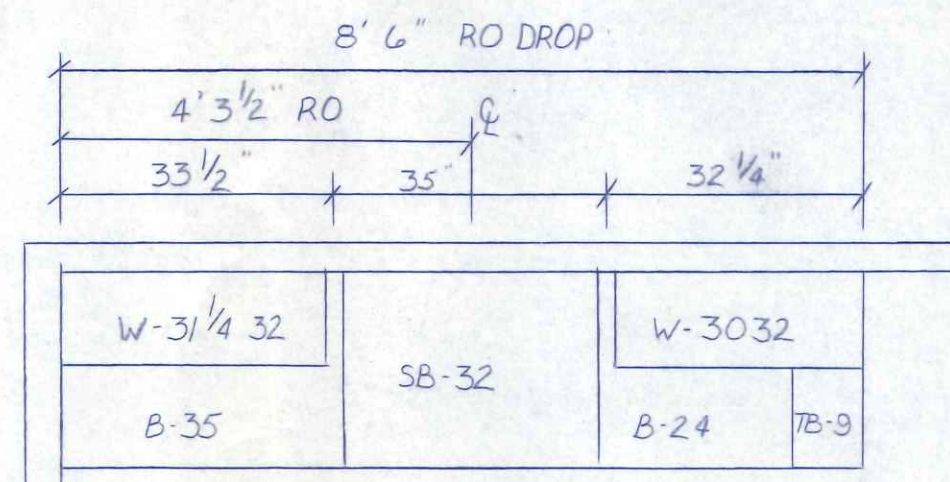
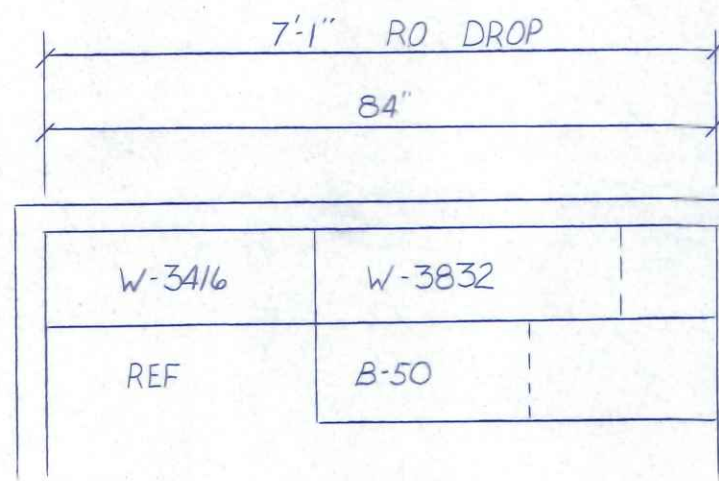
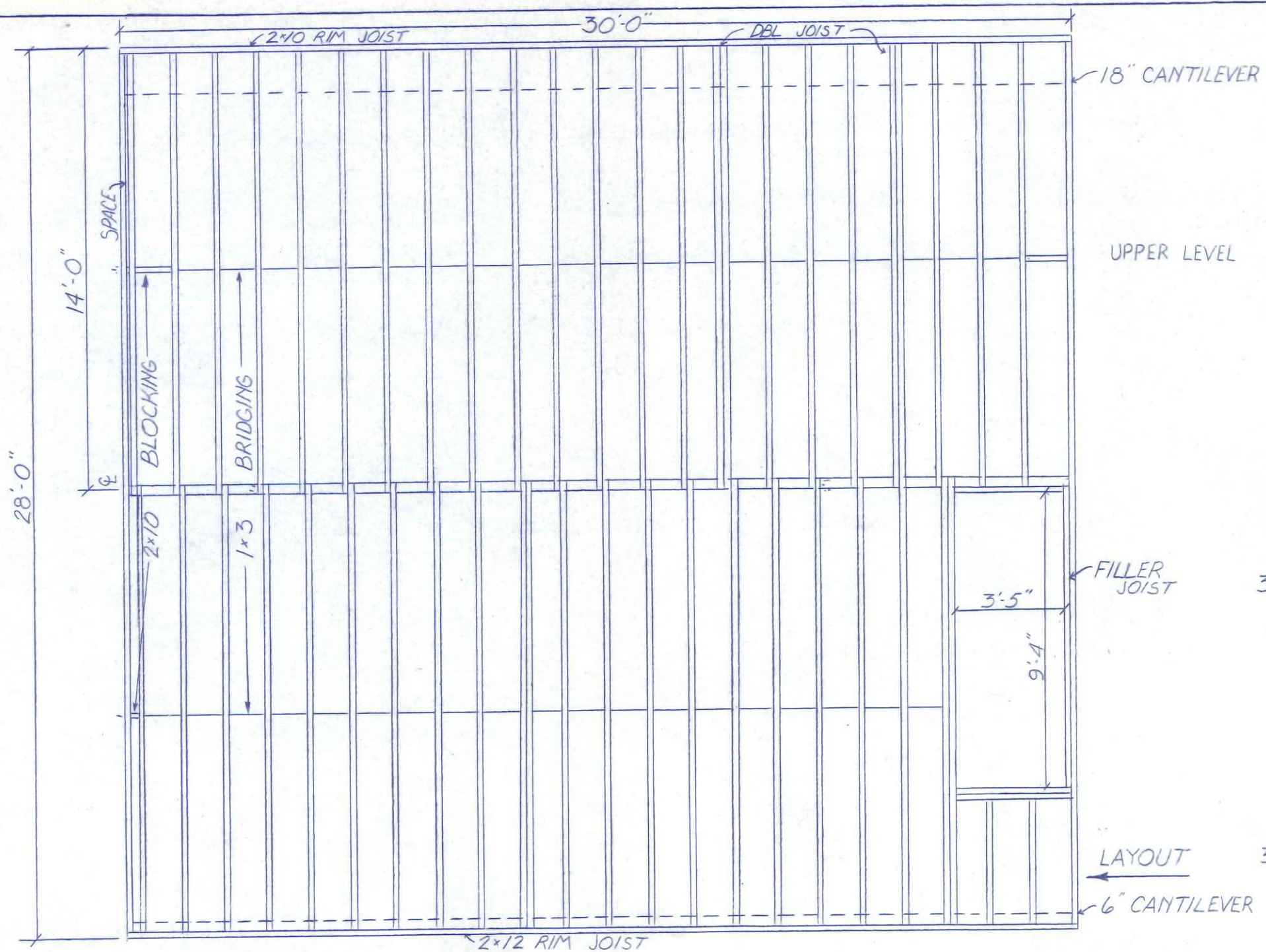

BEAM DETAIL

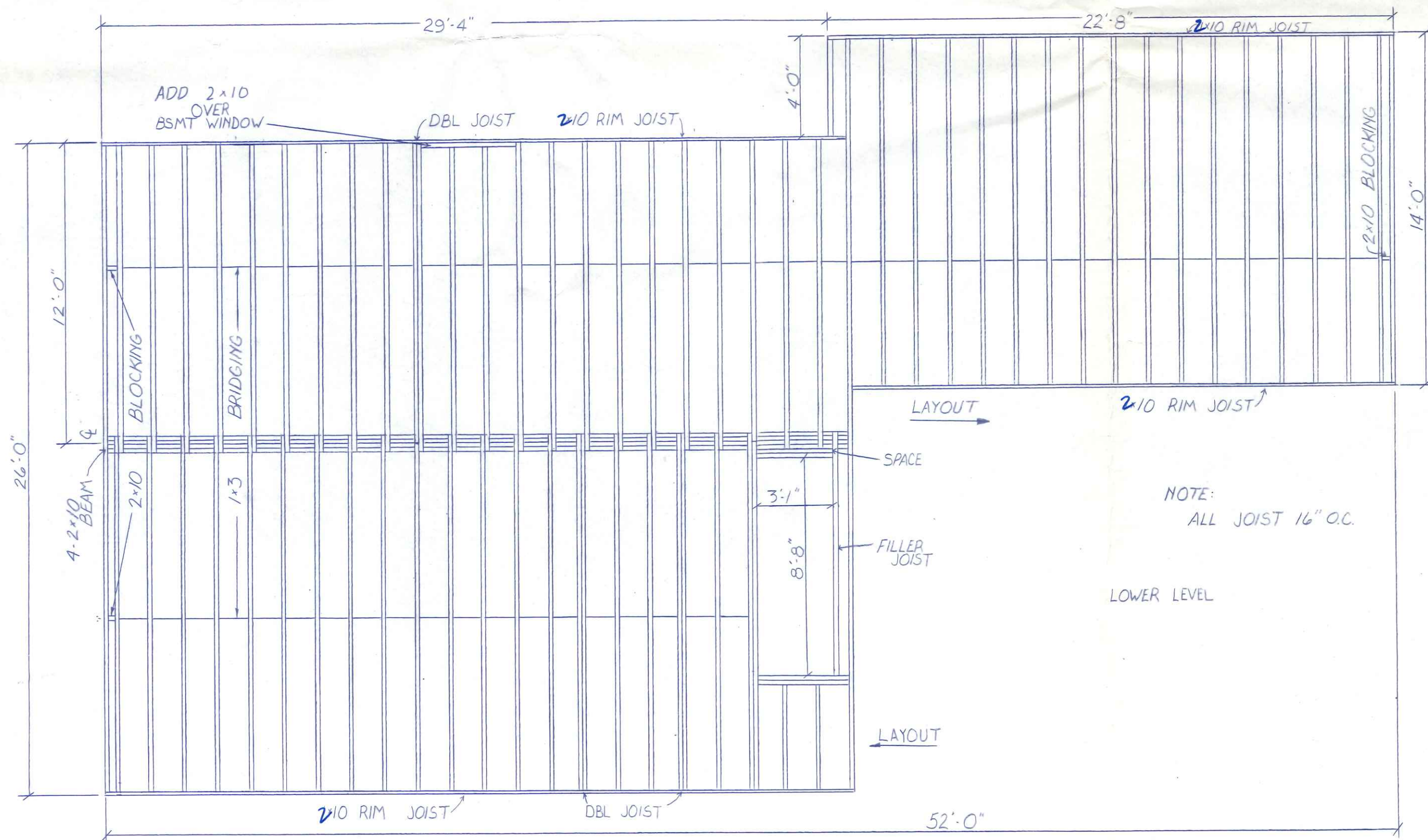

NOTE: ALL JOIST 16" O.C.

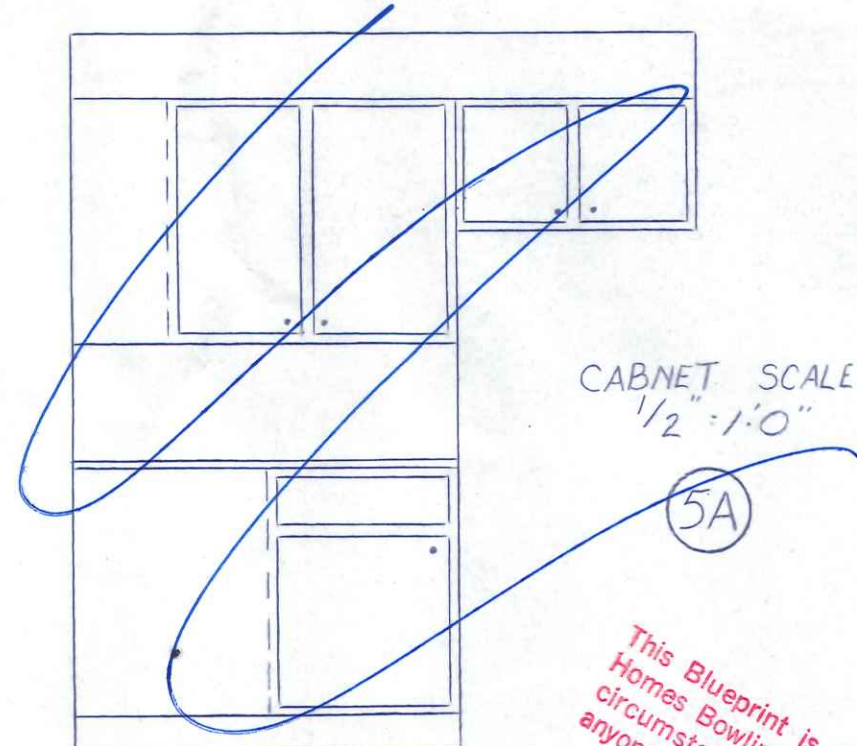

See Attached Drawing (Page 3) for Cabinet layout

This Blueprint is property to Wayne Homes Bowling Green and under no circumstances to be returned to anyone but Wayne Homes Bowling Green.

2ST3 WAYNE HOMES		2 STORY WHISTLER II	
SCALE: 1/4" = 1'	APPROVED BY	DRAWN BY	
DATE: 12-10-86	F.E.W.		
			DWG NO 5-8

DIAGONAL  
 29'-4" x 26'-4" ~~WALL~~  
 22'-8" x 14'-4" = 26'-10"  
 22 x 22 = 31'-1"

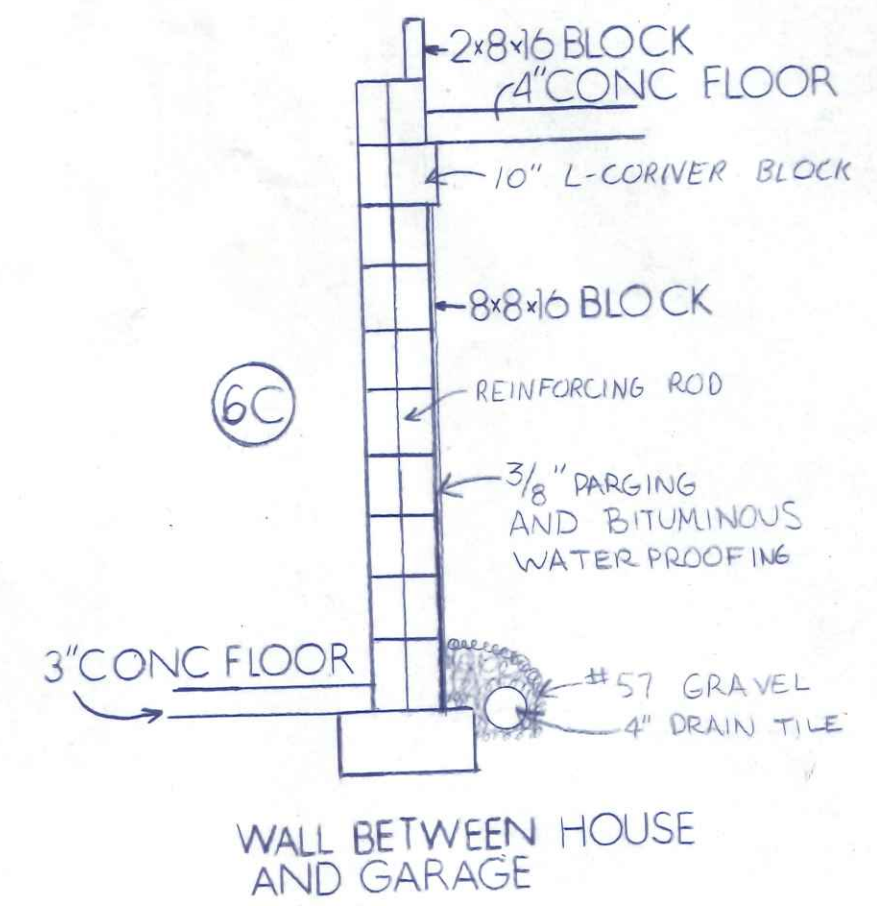
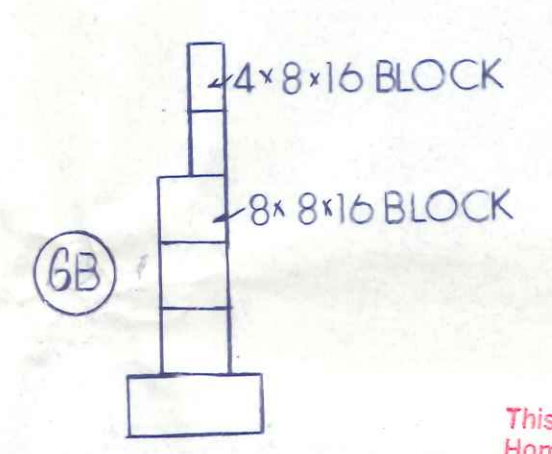
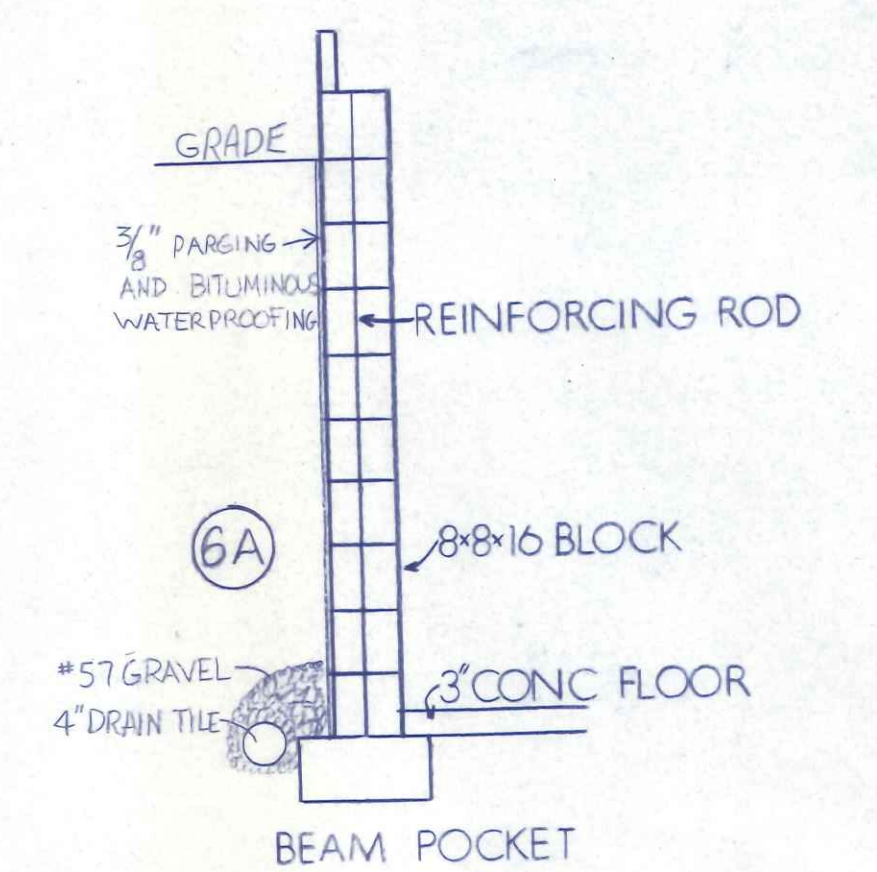
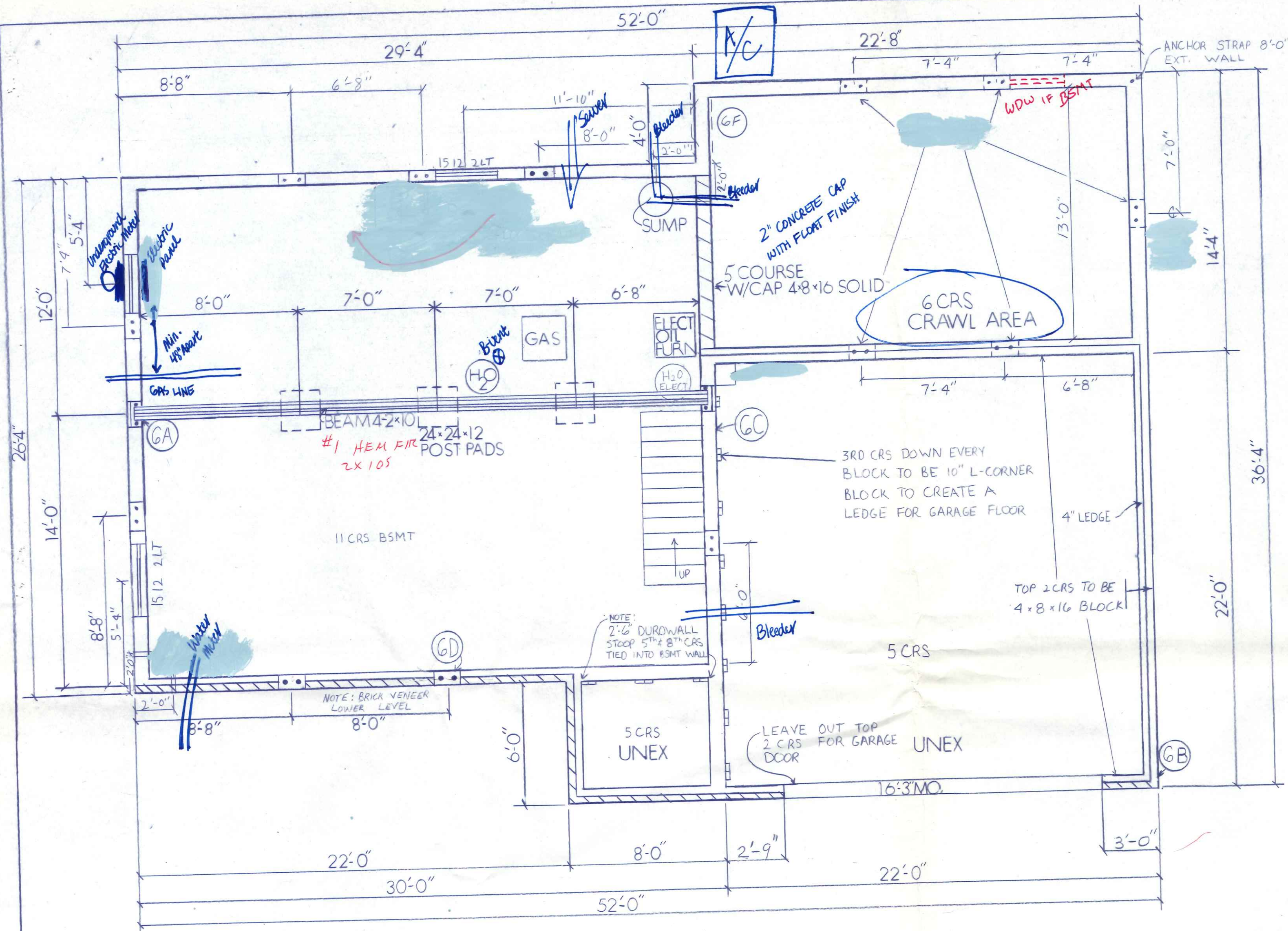

This Blueprint is property to Wayne Homes Bowling Green and under no circumstances to be returned to anyone but Wayne Homes Bowling Green.

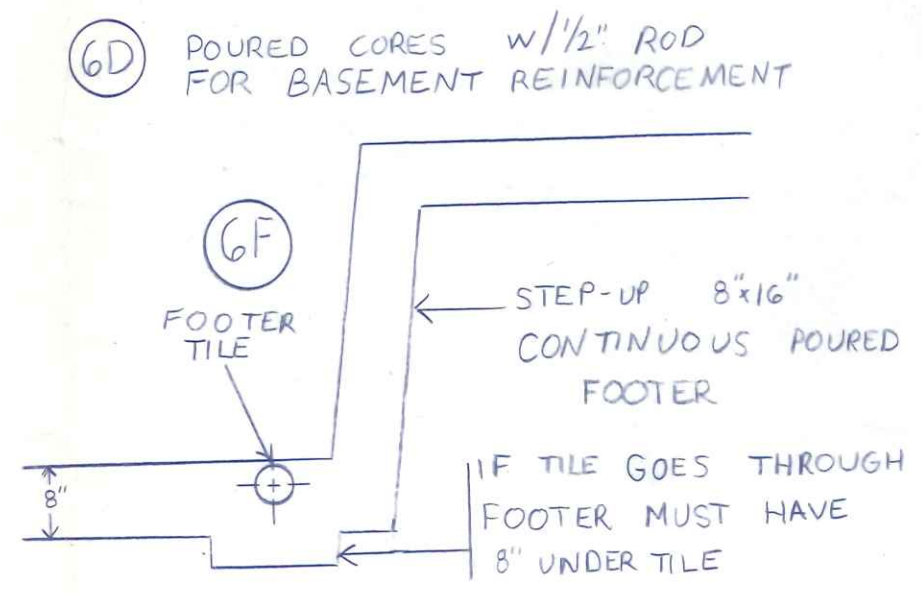

2ST3 WAYNE HOMES 2STORY WHISTLER II		
SCALE 1/4"=1'	APPROVED BY: F.P.W.	DRAWN BY: DS
DATE 12-10-86		
		DWG. NO. 6 of 8

HEM FIR - FLOOR JOISTS + HEADERS

15 LB FELT PAPER  
4" SIDE LAP  
2" TOP LAP

1/16 WAFER BOARD  
W/CLIPS

ENGINEERED TRUSSES  
2'-0" O.C.

APPROVED SHINGLES

R-30

FALSE CEILING  
ABOVE STAIR RAKE

METAL DRIP EDGE  
2x6 FASCIA COVERED W/ALUM.  
ALUM SOFFIT

- 7A 8x8x16 CONC. BLOCK w/3/8 PARGING AND BITUMINOUS WATERPROOFING
- 7B R-13 INS. BATT. W/002 POLY
- 7C DRIP EDGE NAILED AT EACH TRUSS
- 7D MM CEILING INS. R-30

1/2" BLACK BOARD SHEATHING WITH MTL CORNER BRACING OR PART 89

DBL TOP PLATE

2x10 RIM JOIST

2x4 STUDS

2x12 RIM JOIST

2x4 CEILING JOIST

WROUGHT IRON RAILING

3/4" T+G

STAIR RAKE (3)

2x4 NAILER

2x10 CEILING NAILER

2x10

2x8

DBL 2x4 CCA POST WRAPPED W/1x6 CCA

2x10 STRINGER

WOOD SPINDLES

2x4 STRINGER SPACER

3-2x10 STRINGERS

13 RISERS

8" RISE

10" TREADS

15# FELT FLASHING

2x4 SILL PLATE

4" CONC. FLOOR

ALUM SIDING

BOTTOM PLATE

3/4" T+G

SOLID BLOCKING

2x10 RIM JOIST

ANCHOR STRAP

8" O.C. EXTERIOR WALLS

10" L-CORNER BLOCK

ONE COURSE GRADE

ONE COURSE GRADE

2x8 SILL PLATE

ANCHOR STRAP

4-2x10 BEAM

3" STEEL POST

12 RISERS

8 1/8" RISE

10" TREADS

3-2x10 STRINGERS

#57 GRAVEL

4" DRAIN TILE

8x16 CONC. FOOTER

3 1/2" CONC. FLOOR

2x2x12" POST/PIER FOOTER

4" GRAVEL

This Blueprint is property to Wayne Homes Bowling Green and under no circumstances to be returned to anyone but Wayne Homes Bowling Green.

2 ST 3 WAYNE HOMES		
2 STORY WHISTLER II		
SCALE: 1/2" = 1'	APPROVED BY	DRAWN BY
DATE: 12-10-86	FELW	
		DWG NO
		7 of 8

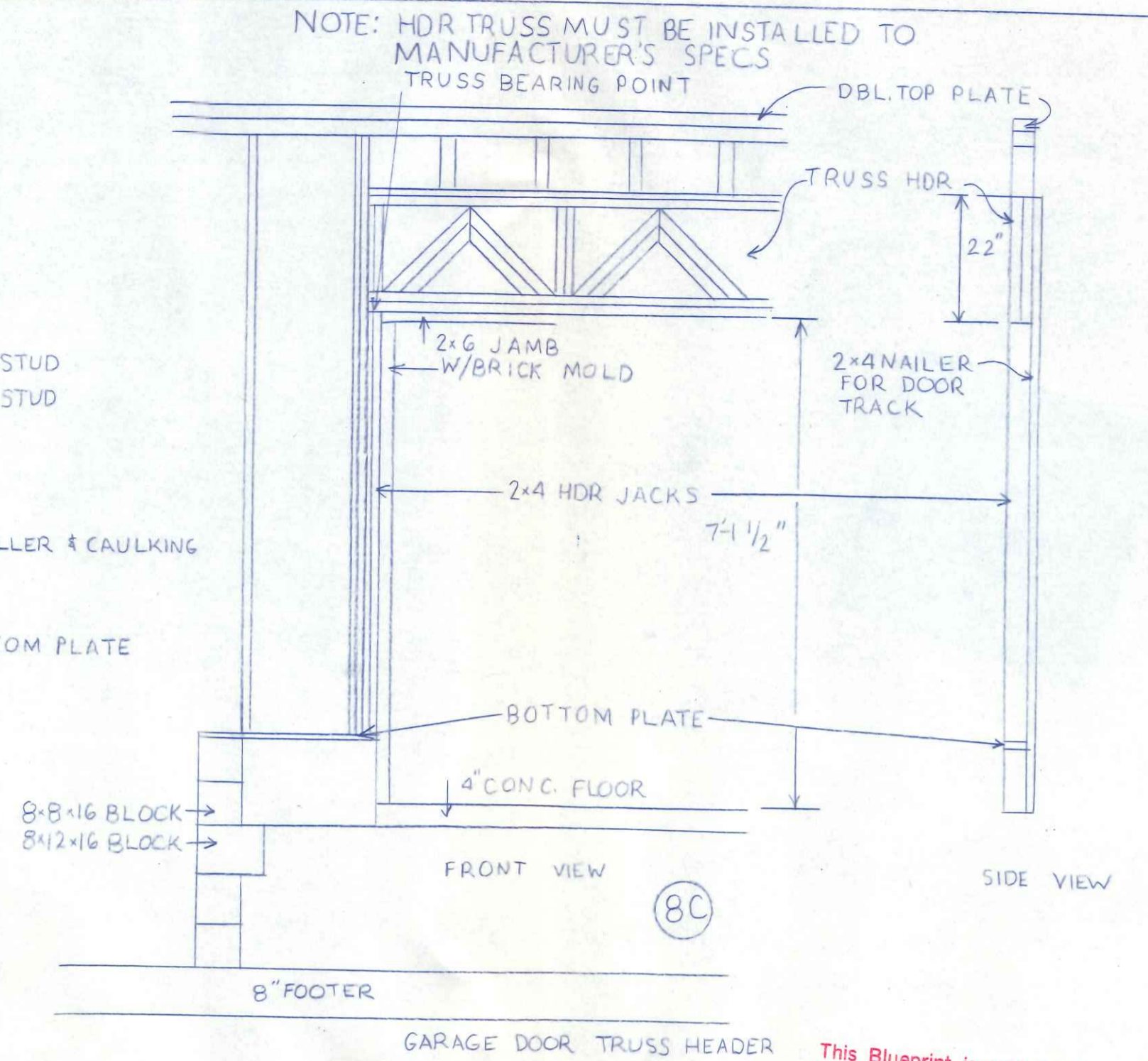
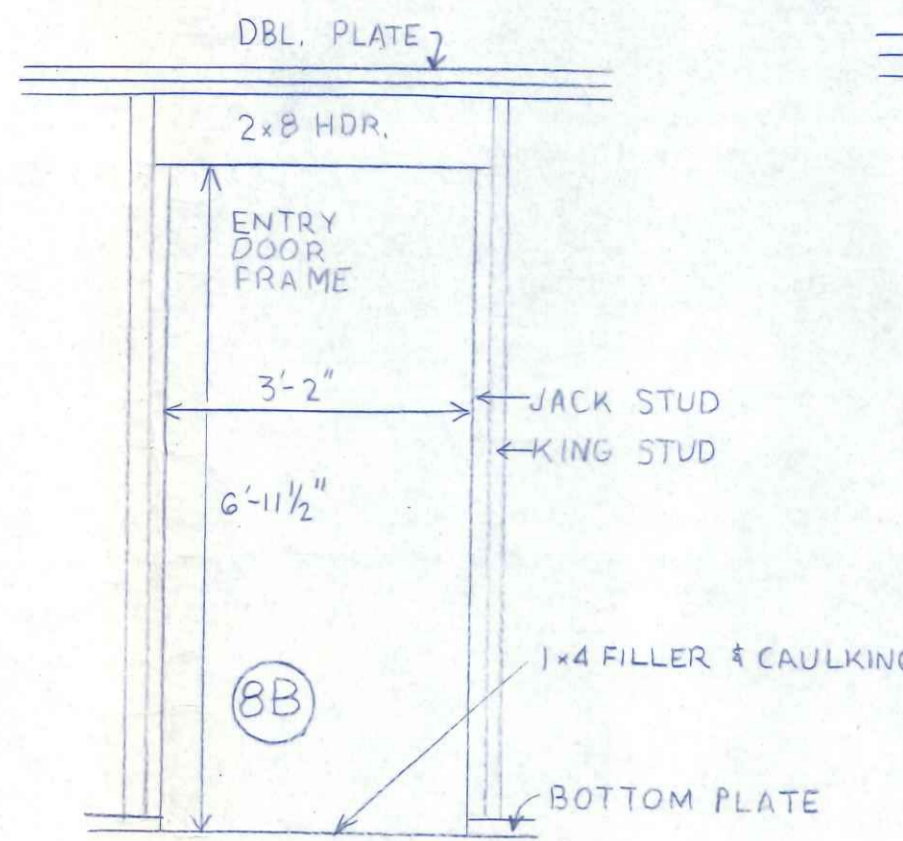
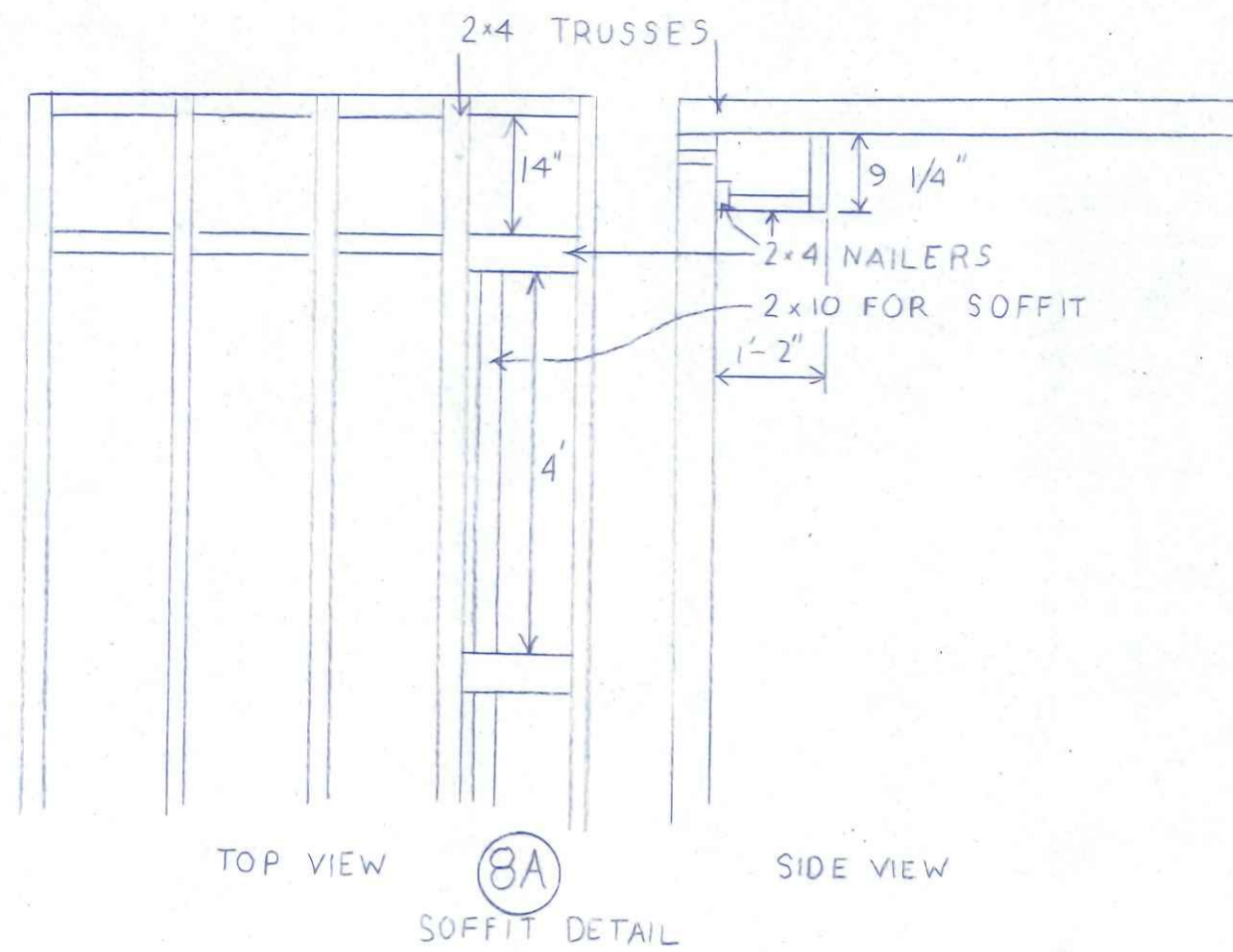

This Blueprint is property to Wayne Homes Bowling Green and under no circumstances to be returned to anyone but Wayne Homes Bowling Green.

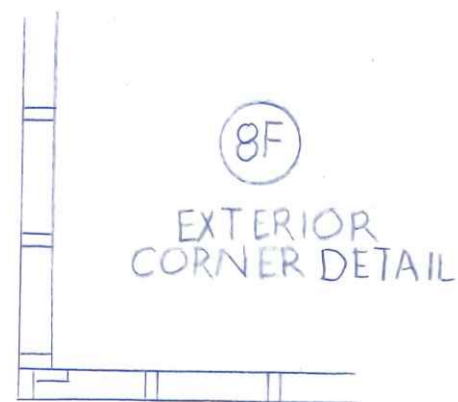
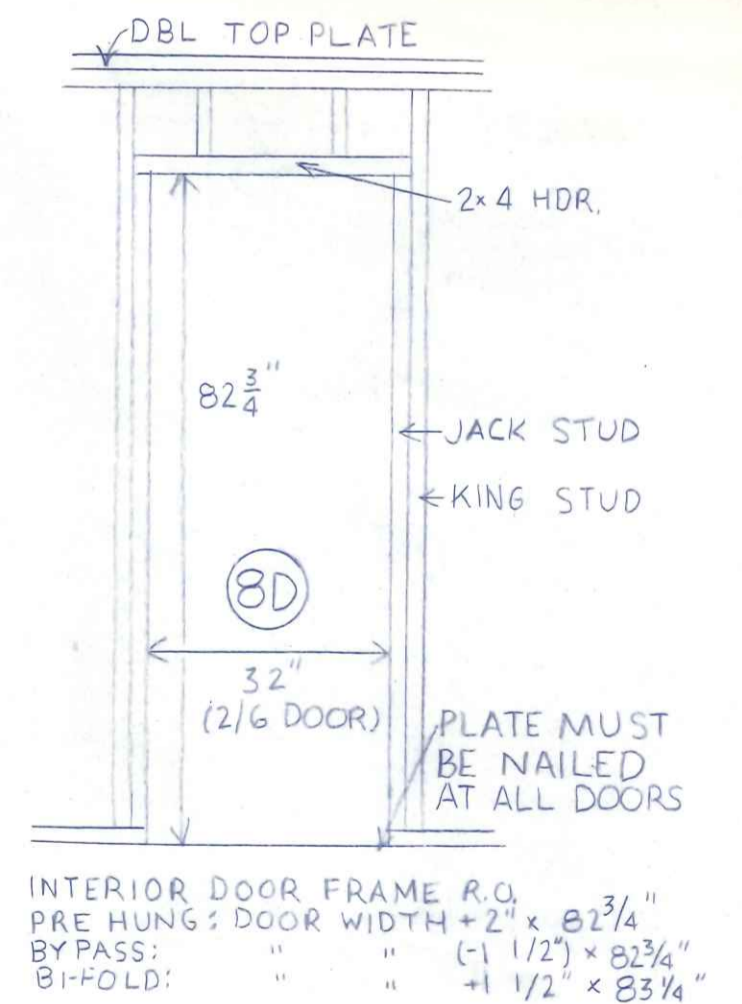
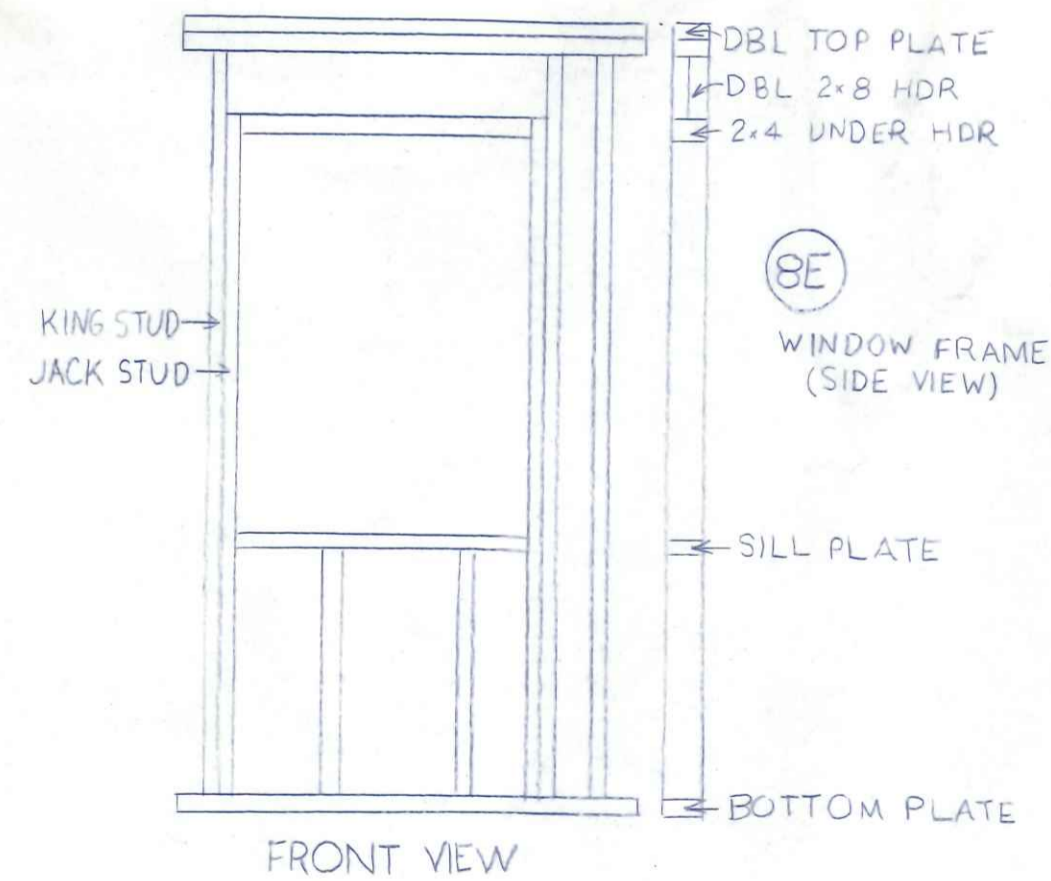
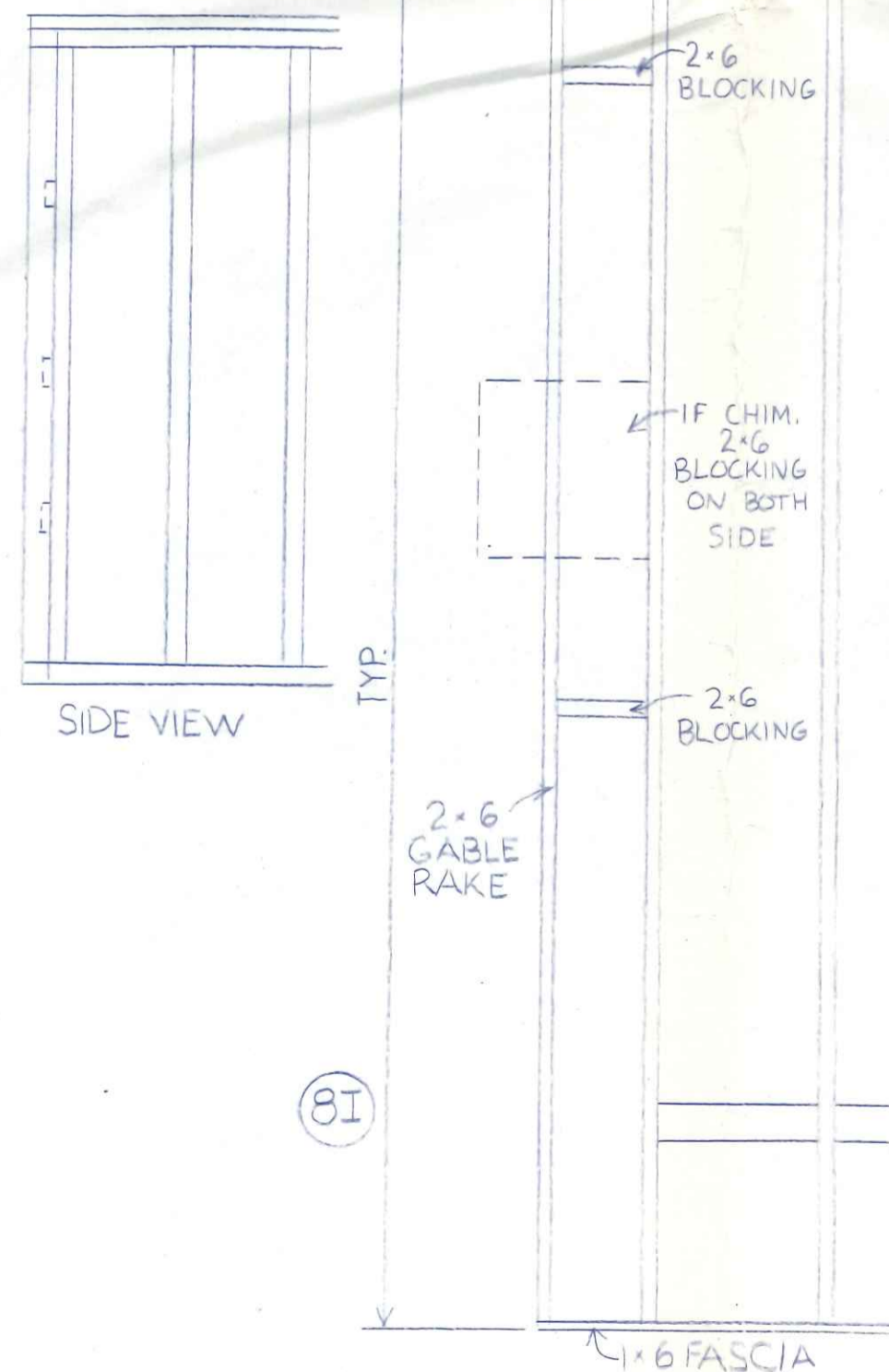
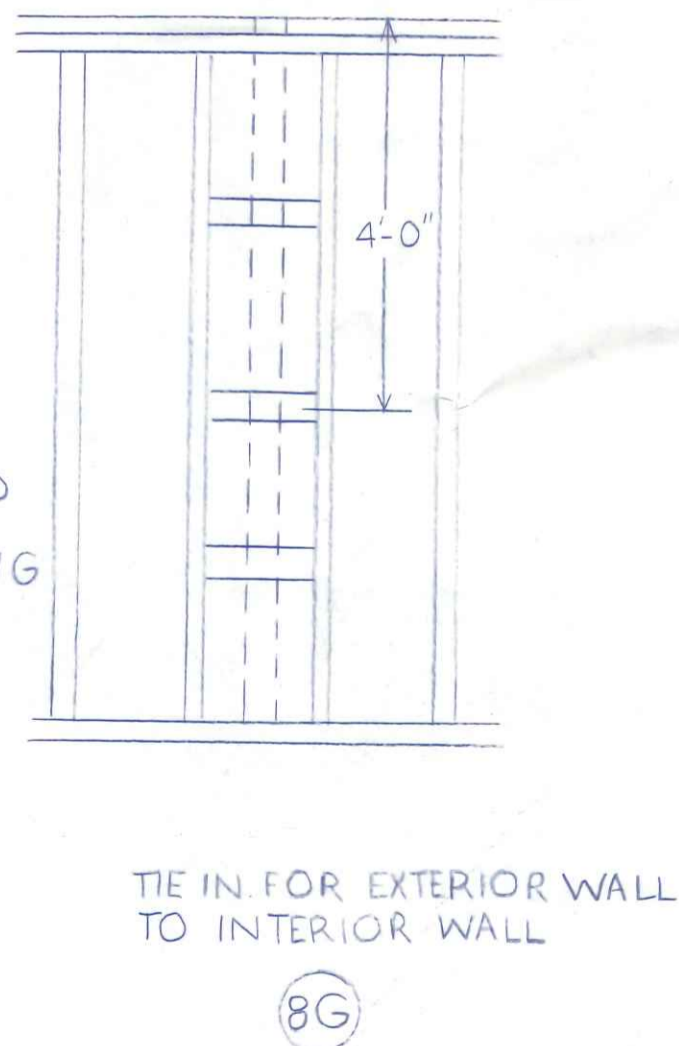
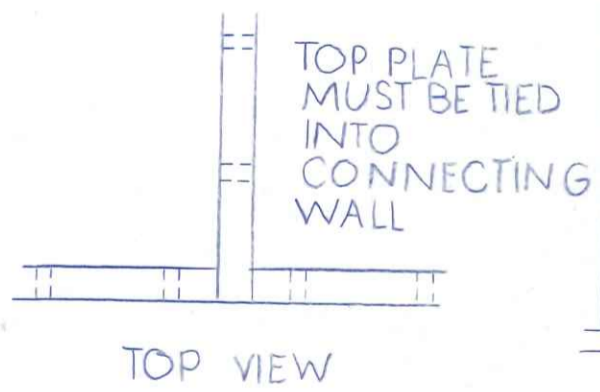

2ST3 WAYNE HOMES 2 STORY WHISTLER II		
SCALE: 1/2" = 1'	APPROVED BY JEW	DRAWN BY DS
DATE: 12-10-86		
		DWG NO 8 of 8



SPECIAL CABT LAYOUT

FINISHED OAK W/

LAMINATE COUNTERTOPS W/ OAK TRIM

DELETE SOFFIT, ADD PLATE RAIL

PFR  
PB  
10/9/88

